



More Precision

thicknessSENSOR // The sensor for precise thickness measurements



The sensor for precise thickness measurements

thicknessSENSOR

Immediately ready for use due to perfectly harmonized components

Easy integration and operation

Precise measurement results with high dynamics

Non-contact and wear-free measurement

Compact system



The new thicknessSENSOR is a sensor system for precise thickness measurement of strip and plate material. This fully assembled system comprises a stable frame where two laser triangulation sensors with small laser line are fixed that detect the thickness of various materials according to the difference principle. The evaluation unit integrated into the frame calculates the thickness values and outputs these via different interfaces.

Compact design and high precision

The thicknessSENSOR enables turnkey thickness measurement along with an unmatched price/performance ratio. Due to its extremely compact design, this sensor system can also be integrated in a confined installation space. Several models with different measuring ranges and widths enable the detection of various object geometries. The integrated laser sensors are perfectly adjusted to each other in terms of their mounting conditions, therefore providing high measurement accuracy.



Fast calibration on site

For calibration purposes, each measurement system includes a reference target which is fixed in the measuring gap using a magnet. This enables the user to quickly teach in the reference value.

Unique ease of use

The thicknessSENSOR is operated using an intuitive web interface. The settings for the measurement task can be quickly selected using predefined presets. Different configuration and set up possibilities enable the user to easily adapt the sensor e.g. to dynamic measurements and different materials.

Up to eight user-specific sensor settings can be stored and exported in the setup management. The signal peak selection and a freely adjustable signal averaging enable the experienced user to optimize the measurement task.

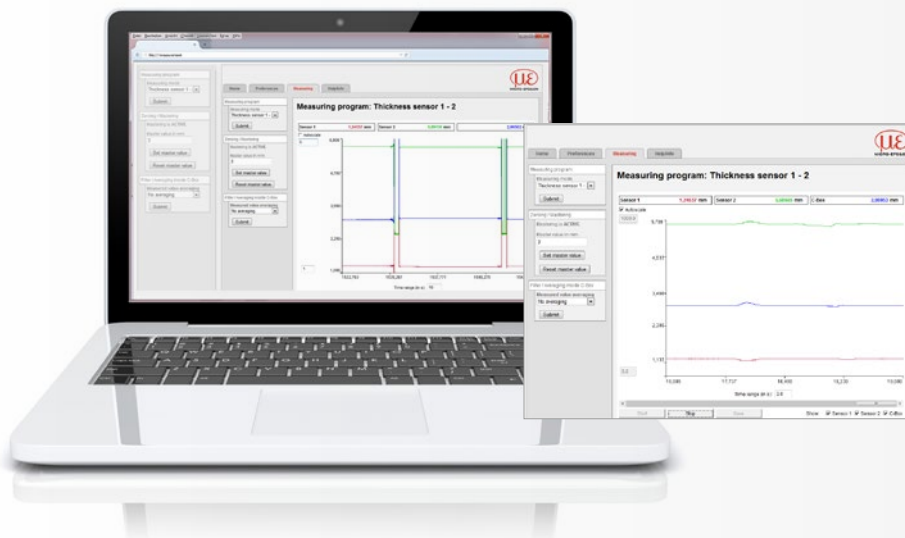

Model	thicknessSENSOR 10/200	thicknessSENSOR 10/400	thicknessSENSOR 25/200	thicknessSENSOR 25/400
Measuring range	10 mm	10 mm	25 mm	25 mm
Working gap	46 mm	46 mm	71 mm	71 mm
Measuring width	200 mm	400 mm	200 mm	400 mm
Linearity (combined)	±10 µm	±10 µm	±40 µm	±40 µm
Measuring rate	0,25 kHz / 0,5 kHz / 1 kHz / 2 kHz / 4 kHz			
Light source	semiconductor laser <1 mW, 670 nm (red)			
Permissible ambient light	20.000 lx			
Light spot diameter (±10 %) ¹⁾	65 x 680 µm		80 x 970 µm	
Protection class	IP65			
Laser safety class	Class 2 according to DIN EN 60825-1 : 2008-05			
Temperature stability	± 0.03 % FSO/°C			
Operating temperature	0 °C... +50 °C (non-condensing)			
Storage temperature	-20 °C ... +70 °C (non-condensing)			
Control inputs/outputs	1 x trigger in / 1 x master / 2 x switching outputs			
Measurement value output	0 ... 5 V, 0 ... 10 V, ± 5 V, ± 10 V, 4 ... 20 mA			
	Ethernet			
Vibration	2 g / 20 ... 500 Hz (according to IEC 60068-2-6)			
Shock	15 g / 6 ms / 3 axes (according to IEC 60068-2-29)			
Weight	3.3 kg	4.3 kg	3.3 kg	4.3 kg
Displays	Sensor	3x color LEDs for power and status		
	Controller	Power i.o.		
Operation	Web interface	Selectable averages / data reduction / setup management / limit values		
Power supply	11 ... 30 VDC, 24 V P< 5 W			
Electronics	integrated signal processor, signal processing unit			
Electromagnetic compatibility (EMC)	EN 61 000-6-3 / DIN EN 61326-1 (Class B) EN 61 000-6-2 / DIN EN 61326-1			

FSO = Full Scale Output

The specified data apply to a white, diffuse reflecting surface (Micro-Epsilon reference ceramic for ILD sensors)

¹⁾ Light spot diameter with line-shaped laser determined based on the emulated 90/10 knife-edge method

Accessories:

SCR3000A-2	Ethernet interface cable, 2 m
SCR3000A-5	Ethernet interface cable, 5 m
SCR3000A-10	Ethernet interface cable, 10 m
SCR3000A-25	Ethernet interface cable, 25 m
SCR3000A-35	Ethernet interface cable, 35 m

PCR3000-2	multifunction cable, 2 m
PCR3000-5	multifunction cable, 5 m
PCR3000-10	multifunction cable, 10 m
PCR3000-25	multifunction cable, 25 m
PCR3000-35	multifunction cable, 35 m

Dimensions

thicknessSENSOR

thicknessSENSOR 10/200

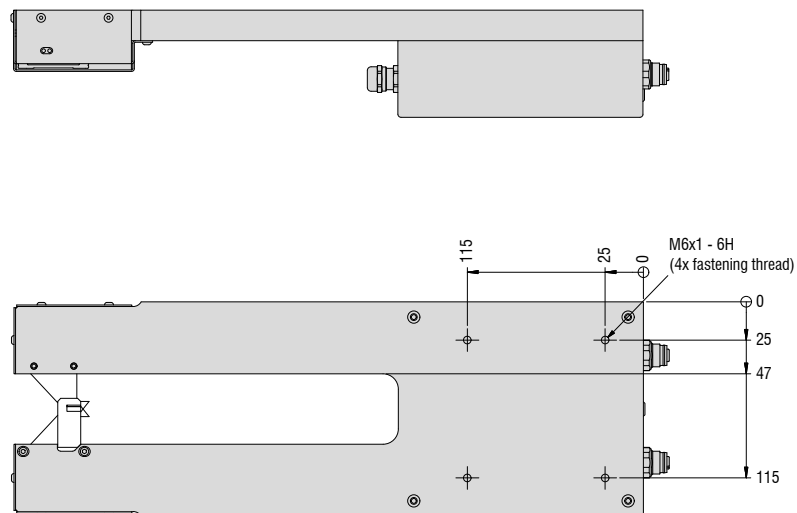
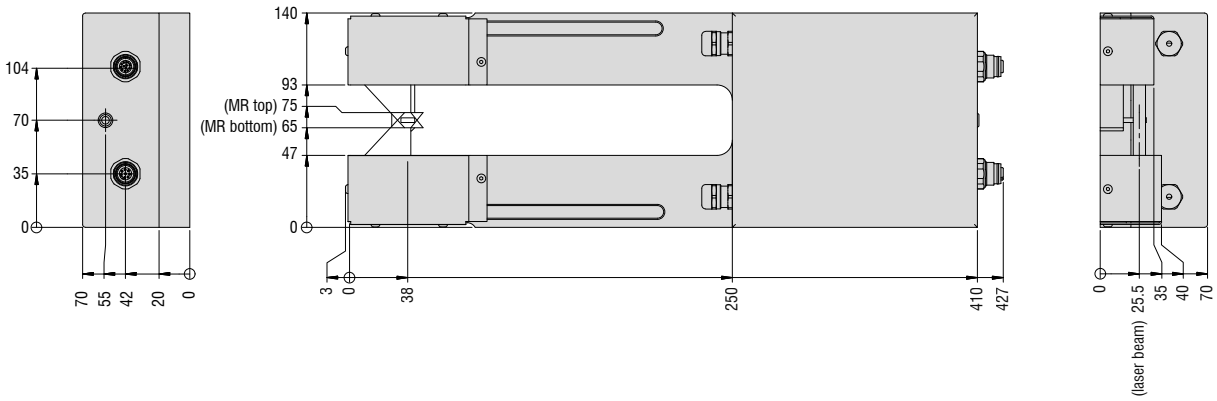
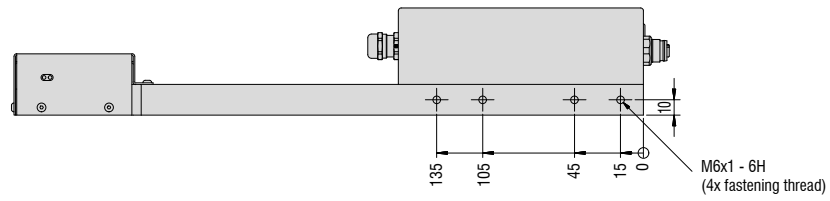

thicknessSENSOR 10/400

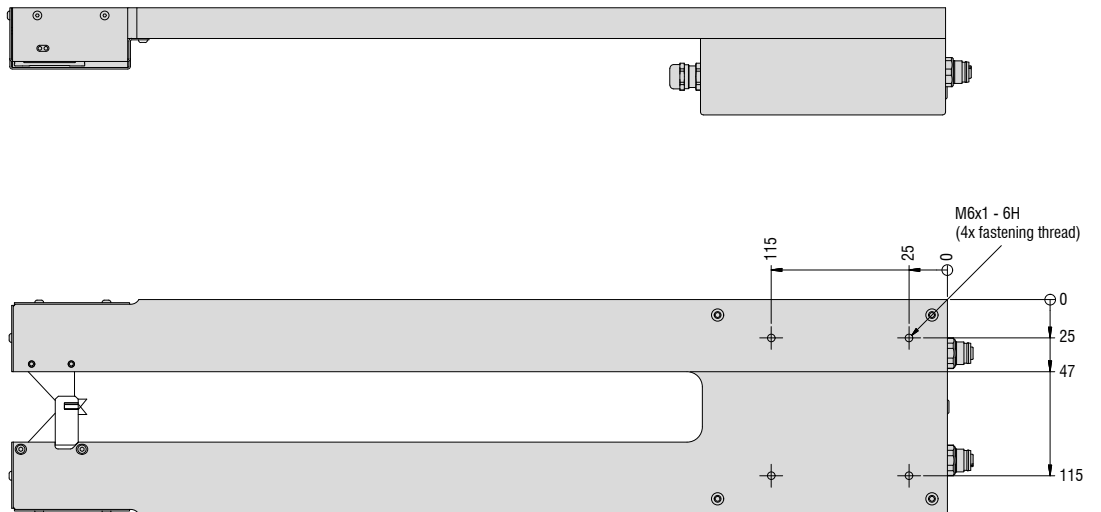
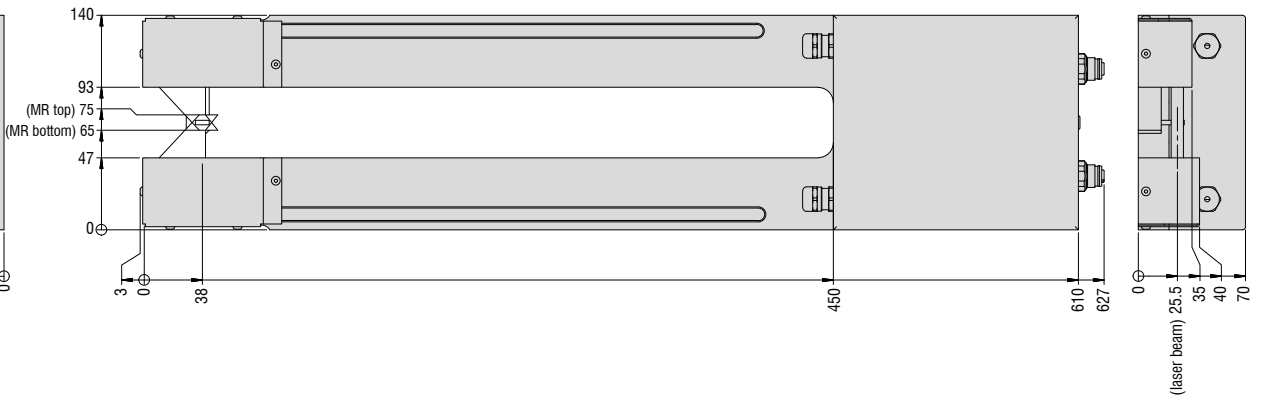
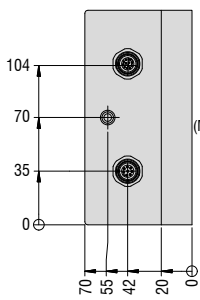
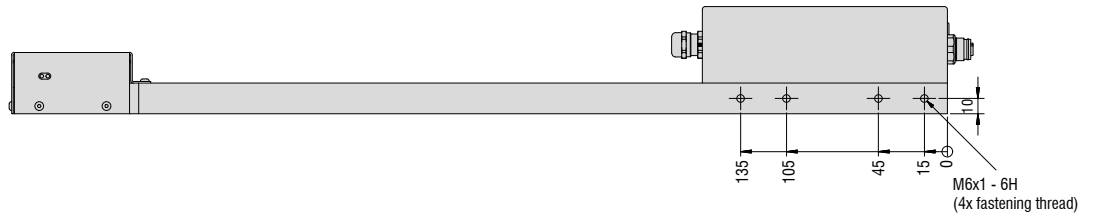

Dimensions

thicknessSENSOR

thicknessSENSOR 25/200

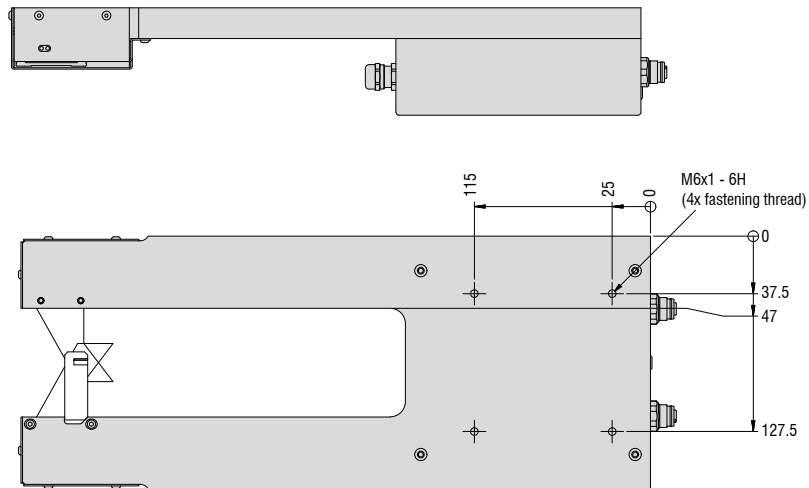
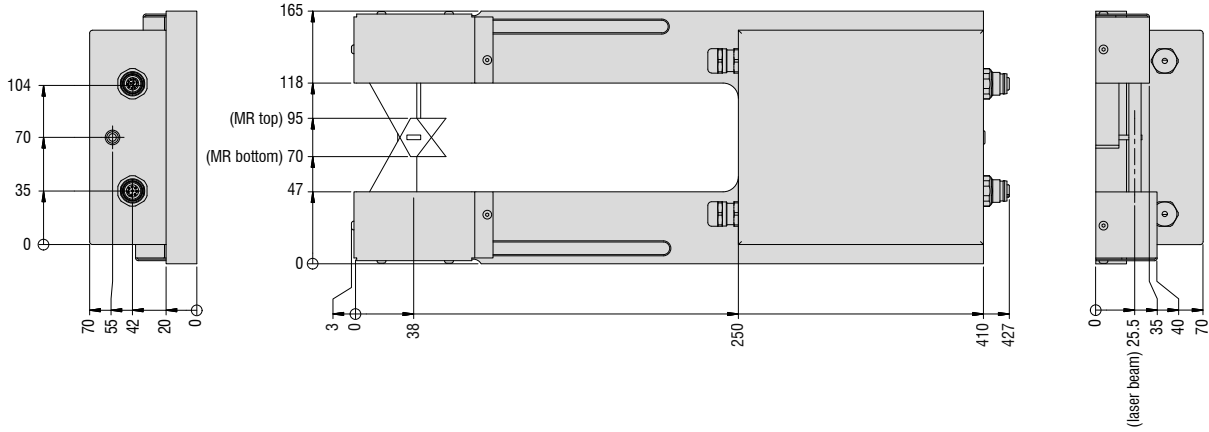
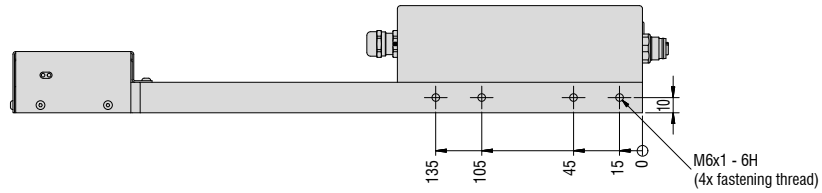

thicknessSENSOR 25/400

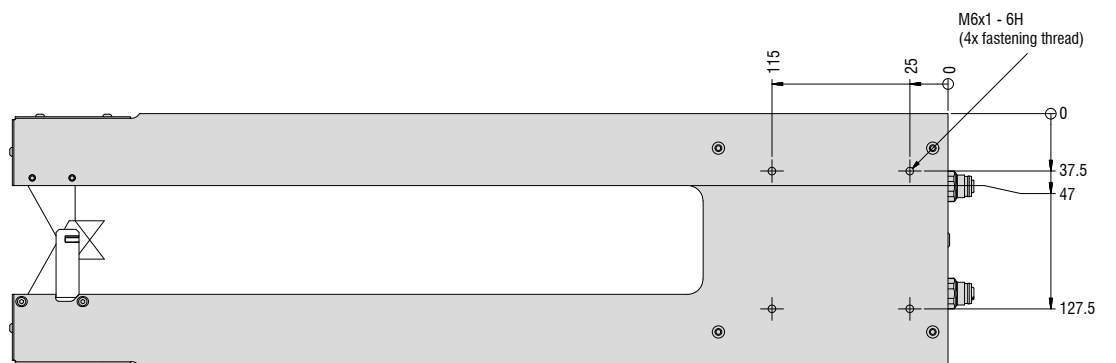
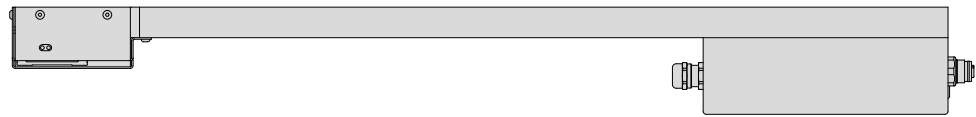
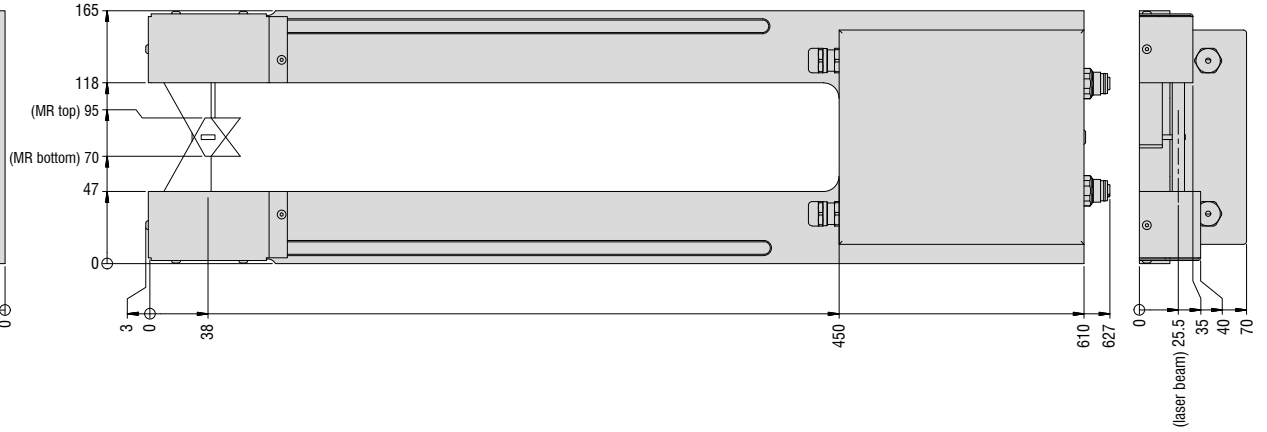
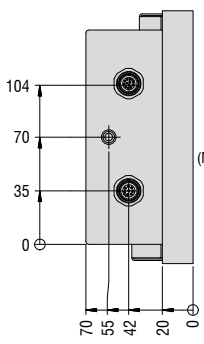
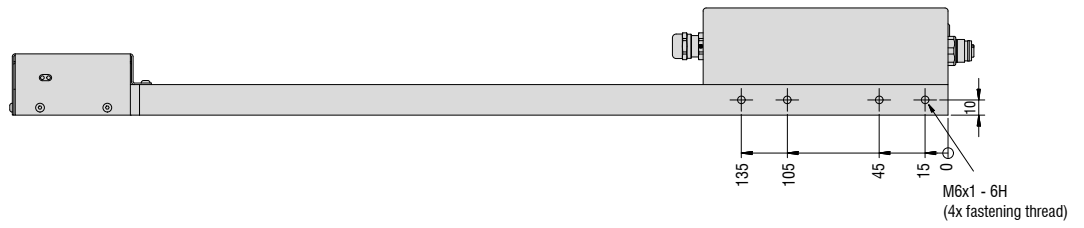

Sensors and Systems from Micro-Epsilon



Sensors and systems for displacement, distance and position



Sensors and measurement devices for non-contact temperature measurement



Measuring and inspection systems for metal strips, plastics and rubber



Optical micrometers and fiber optics, measuring and test amplifiers



Color recognition sensors, LED analyzers and inline color spectrometers



3D measurement technology for dimensional testing and surface inspection