









More Precision.

optoNCDT ILR // Laser-optical distance sensors



High-performance laser distance sensor for industrial applications

optoNCDT ILR2250-100

-  Large measuring range up to 100 m (150 m with reflector)
-  Ideal for OEM serial integration
-  Laser class 2
-  Highest signal stability on numerous surfaces
-  Compact & lightweight design
-  Analog / USB / RS422 / PROFINET / EtherNet/IP / IO-Link
-  Now also with integrated heating for outdoor applications



With the optoNCDT ILR2250-100, Micro-Epsilon presents a new powerful laser distance sensor. The sensor is designed for operation with or without reflector film, which is used depending on the distance and ambient conditions. The sensor measures large distances up to 100 m without contact and provides best results even on challenging (dark, structured or weakly reflecting) surfaces. The measuring range can be extended up to 150 m by attaching a reflector film to the measuring object.

Thanks to the integrated AUTO measurement mode, precise and reliable measurements can be made even on dark, partially reflecting and distant targets. A simple and fast alignment of the sensor is made possible by the integrated mounting plate with 4 set screws.

The ILR2250-100 laser distance sensors provide reliable results even under harsh conditions. They are protected against dust and splashes

of water thanks to the robust design in an IP65 certified die-cast aluminum housing. Compact size combined with low weight opens up new fields of application particularly in factory and plant automation, as well as in drone applications for distance measurement from the air.

New: ILR2250-100-IO with IO-Link

The ILR2250-100-IO model is equipped with an IO-Link interface. The IO-Link communication standard simplifies data communication while reducing the commissioning time of the sensor.

New: ILR2250-100-H with integrated heating

The ILR2250-100-H option has an integrated heating and cooling element that enables operation in the temperature range of -40 °C to +65 °C. This allows the sensors to be used permanently outdoors.

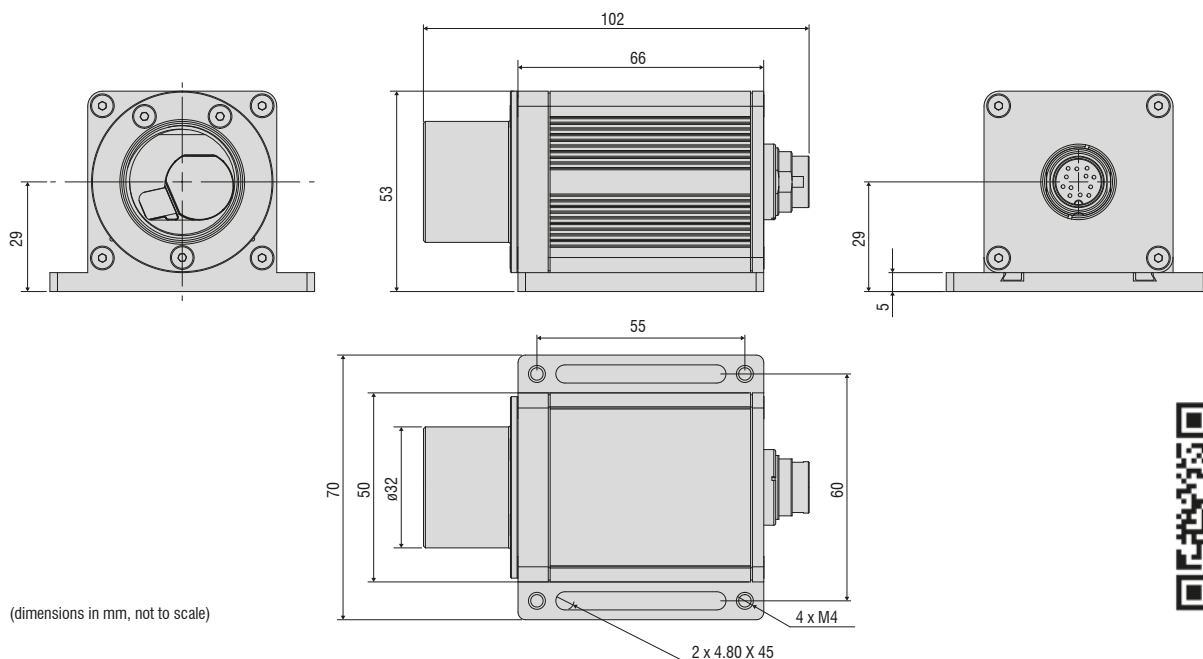

Model	ILR2250-100	ILR2250-100-H	ILR2250-100-IO
Article number	7112015	7112015.200	7112016
Measuring range ¹⁾	SMR		EMR
	black 6 %	0.05 m	30 m
	gray 40 %	0.05 m	70 m
	white 80 %	0.05 m	100 m
	Reflector film ²⁾	35 m	150 m
Measuring rate	20 Hz		
Resolution	0.1 mm		
Linearity	< ±1 mm ³⁾		
Repeatability ⁴⁾	< 300 μm		
Temperature compensation	-10 ... +50 °C	-40 ... +65 °C	-10 ... +50 °C
Light source	Semiconductor laser < 1 mW, 655 nm (red)		
Typ. service life	50,000 h		
Laser class	Class 2 in accordance with DIN EN 60825-1: 2015-07		
Permissible ambient light	50,000 lx		
Supply voltage	10 ... 30 VDC	24 ... 30 VDC	10 ... 30 VDC
Power consumption	< 1.5 W (24 V)	< 10 W (24 V)	< 1.5 W (24 V)
Signal input	Trigger		-
Digital interface	RS422 / USB ⁵⁾ / PROFINET ⁵⁾ / EtherNet/IP ⁵⁾		IO-Link 1.1; process data, parameter set up and diagnostics
Analog output	4 ... 20 mA (16 bit, freely scalable within the measuring range)		-
Switching output	Q1 / Q2 / Q3 (configurable)		Q1 / Q2 / Q3 (configurable) included in IO-Link process data
Connector	Supply/signal: 12-pin M16 screw/plug connection (see accessories for connection cable)		Supply/signal: 5-pin M12 screw/plug connection (see accessories for connection cable)
Assembly	Screwing and adjustment on sensor base plate		
Temperature range	Storage	-25 ... +70 °C (non-condensing)	
	Operation	-10 ... +50 °C (non-condensing)	-40 ... +65 °C (non-condensing)
Shock (DIN EN 60068-2-29)	15 g / 6 ms in 3 axes, in 3 directions, 1000 shocks each		
Vibration (DIN EN 60068-2-6)	15 g / 10 ... 500 Hz in 3 axes, 10 cycles each		
Protection class (DIN EN 60529)	IP65		
Material	Aluminum housing		
Weight	approx. 265 g	approx. 270 g	approx. 265 g
Control and indicator elements	5x LEDs for power, signal strength and switching outputs	5x LEDs for power, signal strength, heating and switching outputs	5x LEDs for power, signal strength and switching outputs
Special features	4 measurement-specific operating modes via sensorTOOL		4 measurement-specific operating modes via IO-Link

SMR = Start of measuring range, EMR = End of measuring range

The specified data apply for a consistent room temperature of 20 °C, sensor is continuously in operation. Measured on white, diffuse reflecting surface (reference ceramic)

¹⁾ Depends on the reflectivity of the target, ambient light interference and atmospheric conditions

²⁾ ILR-RF210 reflector film 210 x 297 mm; article no: 7966058

³⁾ Measured in the range of 0.05 ... 20 m; statistical spread 2 σ

⁴⁾ Measurement frequency of 20 Hz, moving average 10

⁵⁾ Connection via interface module (see accessories)

Oval spot diameter ILR2250-100

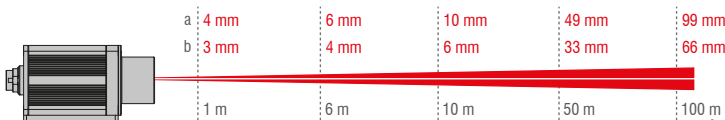

The ILR2250 sensor works with a semiconductor laser at a wavelength of 655 nm (visible/red). Laser power is < 1 mW. The sensors fall within laser class 2. Devices of this laser class require no special safety precautions.

EtherNet/IP®

PROFI
NET®







Analog

RS422

IO-Link
inside

Accessories optoNCDT ILR

Accessories optoNCDT ILR103x/LC1







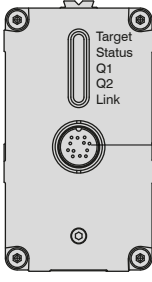

Connection	Interface modules	Connection cables	Sensor	Accessories
Supply/PLC Power supply unit PS2031 Art. no.: 2420096 		Supply and output cable Art. no.: 2901232 (2 m) 2901233 (2 m, 90°) 2901234 (5 m) 2901235 (5 m, 90°) 2901268 (10 m, 90°) 29011248 (10 m)		Reflector 250 x 250 mm Art. no.: 7966001 
Digital output/Ethernet 	IF1032/ETH Art. no.: 2420066 			

Accessories optoNCDT ILR2250-100 / ILR2250-100-H / ILR2250-100-IO

Connection	Interface modules	Connection cables	Sensor	Accessories
Supply/PLC Power supply unit PS2031 Art. no.: 2420096 		Supply and output cable Art. no.: 2901524 (3 m) 2901239 (3 m, 90°) 2901573 (5 m) 2901240 (5 m, 90°) 2901236 (10 m) 2901241 (10 m, 90°) 2901237 (20 m) 2901242 (20 m, 90°) 2901238 (30 m) 2901243 (30 m, 90°)	ILR2250-100 ILR2250-100-H 	Reflector 210 x 297 mm Art. no.: 7966058 
PLC Ethernet 	IF2030 for PROFINET Art. no.: 2420087  IF2030 for EtherNet/IP Art. no.: 2420088 			
Digital output/Ethernet 	IF2001/USB Art. no.: 2213025 		 Air purge collar Art. no.: 7966062	
	IC2001/USB Art. no.: 2213041 			
	IF1032/ETH Art. no.: 2420066 			Protective glass Art. no.: 7966061 
	IF2004/USB Art. no.: 2213024 	Art. no.: 29011342 (3 m) 29011347 (5 m) 29011348 (10 m) 29011372 (20 m) 2x 2901528 (0.3 m)		
PLC Ethernet 	IF2008/ETH for 8 sensors Art. no.: 2213030 	Art. no.: 29011107 (5 m) 29011398 (3 m) 	Filter glass Art. no.: 7966063 ILR-NDF 0.75 7966066 ILR-NDF 0.5 7966068 ILR-NDF 0.9 	
	IO-Link master 	IO-Link standard cable Art. no.: 29011362 (5 m) 29011363 (10 m) 29011364 (15 m) 		ILR2250-100-IO Sensor + adapter cable (0.3 m)  

Accessories optoNCDT ILR

Accessories optoNCDT ILR1 191-300

Connection	Interface modules	Connection cables	Assembly	Accessories
Supply/PLC Power supply unit PS2031 Art. no.: 2420096 		Supply and output cable Art. no.: 2901524 (3 m) 2901239 (3 m, 90°) 2901573 (5 m) 2901240 (5 m, 90°) 2901236 (10 m) 2901241 (10 m, 90°) 2901237 (20 m) 2901242 (20 m, 90°) 2901238 (30 m) 2901243 (30 m, 90°)	Electrical connections  <p>Target Status Q1 Q2 Link</p> <p>Supply / RS232/422</p>	Reflector 250 x 250 mm Art. no.: 7966001 
Digital output/Ethernet 	IF2001/USB Art. no.: 2213025 			Mounting plate Art. no.: 7966014 
	IF1032/ETH Art. no.: 2420066 			Protection tube Art. no.: 7966016 
				Alignment aid Art. no.: 7966060 

Sensors and Systems from Micro-Epsilon



Sensors and systems for displacement, position and dimension



Sensors and measurement devices for non-contact temperature measurement



Measuring and inspection systems for quality assurance



Optical micrometers, fiber optics, measuring and test amplifiers



Color recognition sensors, LED Analyzers and inline color spectrometers



3D measurement technology for dimensional testing and surface inspection