



# More Precision







**confocalDT** // Confocal chromatic sensor system

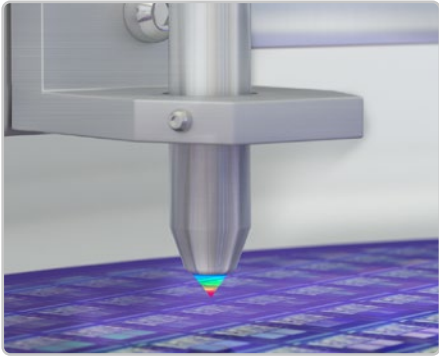

# High precision sensors for displacement and thickness measurements

## confocalDT IFS2407



-  Compact sensors from ø12 mm
-  Submicron resolution
-  For one-sided thickness measurements
-  For precise distance measurements
-  Very small light spot
-  Large tilt angle

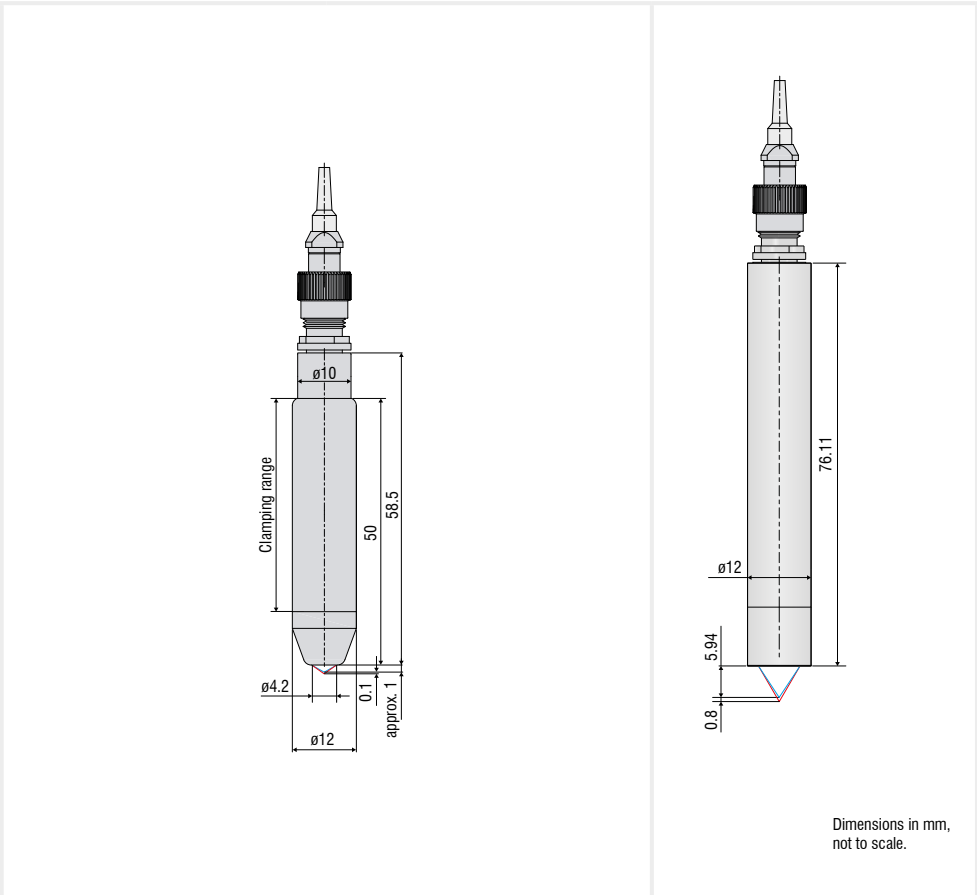

Model		IFS2407-0.1	IFS2407-0.1(001)	IFS2407-0.8
Measuring range		0.1 mm	0.1 mm	0.8 mm
Start of measuring range	approx.	1 mm	1 mm	5.9 mm
Resolution	static <sup>1)</sup>	3 nm	3 nm	24 nm
	dynamic <sup>2)</sup>	6 nm	6 nm	75 nm
Linearity <sup>3)</sup>	Displacement and distance	< ±0.05 µm	< ±0.05 µm	< ±0.2 µm
	Thickness	< ±0.1 µm	< ±0.1 µm	< ±0.4 µm
Light spot diameter		3 µm	4 µm	6 µm
Max. measuring angle <sup>4)</sup>		±48°	±48°	±30°
Numerical aperture (NA)		0.80	0.70	0.50
Min. target thickness <sup>5)</sup>		0.005 mm	0.005 mm	0.04 mm
Target material		reflective, diffuse as well as transparent surfaces (e.g. glass)		
Connection		pluggable optical fiber via FC socket, standard length 3 m; extension up to 50 m; bending radius: static 30 mm; dynamic 40 mm		
Installation		Clamping (mounting adapter see accessories)		
Temperature range	Storage	-20 ... +70 °C		
	Operation	+5 ... +70 °C		
Shock (DIN EN 60068-2-27)		15 g / 6 ms in XY axis, 1000 shocks each		
Vibration (DIN EN 60068-2-6)		2 g / 20 ... 500 Hz in XY axis, 10 cycles each		
Protection class (DIN EN 60529)		IP65 (front)		
Material		Stainless steel housing, glass lenses		
Weight <sup>6)</sup>		approx. 36 g	approx. 36 g	approx. 40 g
Special features		Sensor with high numerical aperture	Light-intensive sensor	-

<sup>1)</sup> Average from 512 values at 1 kHz, in the mid of the measuring range onto optical flat

<sup>2)</sup> RMS noise relates to mid of measuring range (1 kHz)

<sup>3)</sup> All data at constant ambient temperature (25 ± 1 °C) against optical flat; specifications can change when measuring different objects.

<sup>4)</sup> Maximum measuring angle of the sensor that produces a usable signal on reflecting surfaces. The accuracy decreases when approaching the limit values.

<sup>5)</sup> Glass sheet with refractive index n = 1.5 throughout the entire measuring range. In the mid of the measuring range, also thinner layers can be measured.

<sup>6)</sup> Sensor weight without optical fiber

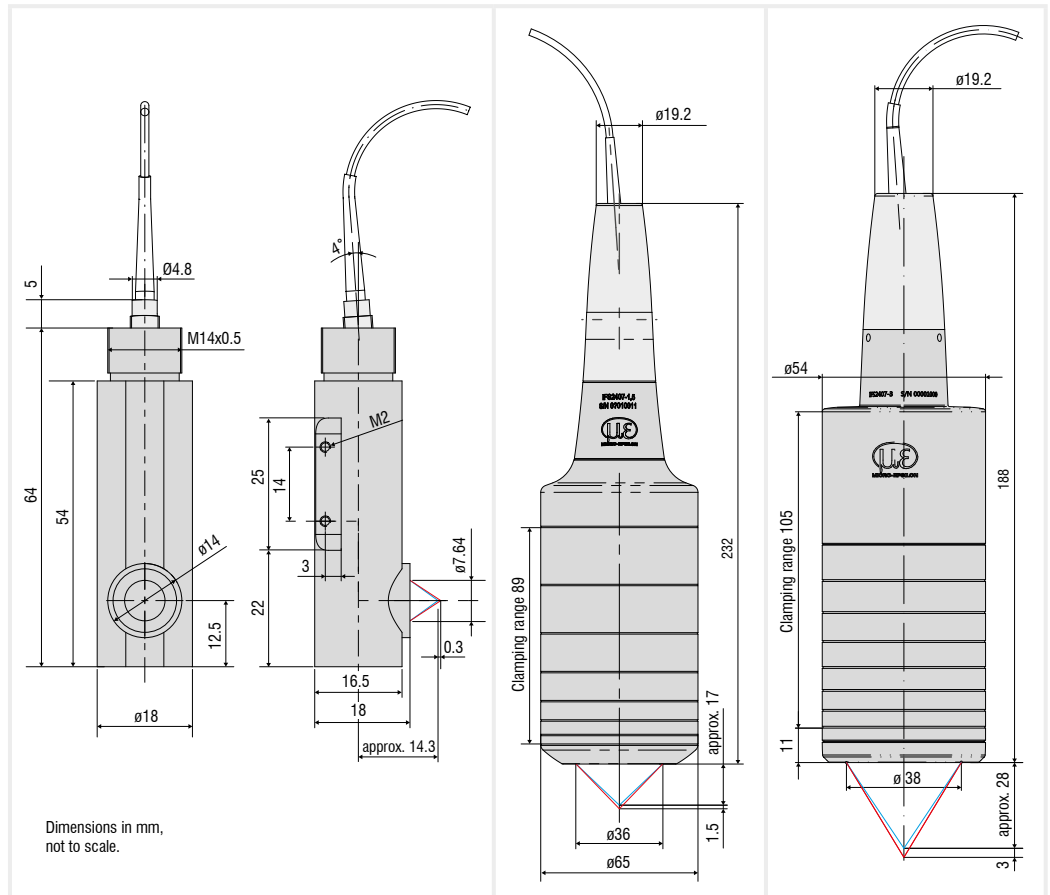

Model	IFS2407/90-0,3	IFS2407-1,5	IFS2407-3
Measuring range	0.3 mm	1.5 mm	3 mm
Start of measuring range	approx. 5.3 mm	17 mm	28 mm
Resolution	static <sup>1)</sup> 6 nm dynamic <sup>2)</sup> 20 nm	6 nm	13 nm
Linearity <sup>3)</sup>	Displacement and distance < $\pm 0.15 \mu\text{m}$ Thickness < $\pm 0.3 \mu\text{m}$	< $\pm 0.3 \mu\text{m}$ < $\pm 0.6 \mu\text{m}$	< $\pm 0.5 \mu\text{m}$ < $\pm 1 \mu\text{m}$
Light spot diameter	6 $\mu\text{m}$	5.5 $\mu\text{m}$	9 $\mu\text{m}$
Max. measuring angle <sup>4)</sup>	$\pm 27^\circ$	$\pm 43^\circ (\pm 70^\circ)$ <sup>5)</sup>	$\pm 30^\circ$
Numerical aperture (NA)	0.50	0.70	0.53
Min. target thickness <sup>5)</sup>	0.015 mm	0.075 mm	0.15 mm
Target material	reflective, diffuse as well as transparent surfaces (e.g. glass)		
Connection	pluggable optical fiber via DIN socket, type C2407-x; standard length 3 m; extension up to 50 m; bending radius: static 30 mm, dynamic 40 mm	pluggable optical fiber via FC socket, standard length 3 m; extension up to 50 m; bending radius: static 30 mm, dynamic 40 mm	
Installation	Mounting holes (2x M2)	Clamping (mounting adapter see accessories)	
Temperature range	Storage -20 ... +70 °C Operation +5 ... +70 °C		
Shock (DIN EN 60068-2-27)	15 g / 6 ms in XY axis, 1000 shocks each		
Vibration (DIN EN 60068-2-6)	2 g / 20 ... 500 Hz in XY axis, 10 cycles each		
Protection class (DIN EN 60529)	IP65 (front)		
Material	Stainless steel housing, glass lenses	Aluminum housing, glass lenses	
Weight <sup>7)</sup>	approx. 30 g	approx. 800 g	approx. 550 g

<sup>1)</sup> Average from 512 values at 1 kHz, in the mid of the measuring range onto optical flat

<sup>2)</sup> RMS noise relates to mid of measuring range (1 kHz)

<sup>3)</sup> All data at constant ambient temperature (25  $\pm$  1 °C) against optical flat; specifications can change when measuring different objects.

<sup>4)</sup> Maximum measuring angle of the sensor that produces a usable signal on reflecting surfaces. The accuracy decreases when approaching the limit values.

<sup>5)</sup> Maximum measuring angle of the sensor up to which a usable signal can be obtained on diffusely reflecting metallic surfaces, whereby the accuracy decreases towards the limit values

<sup>6)</sup> Glass sheet with refractive index n = 1.5 throughout the entire measuring range. In the mid of the measuring range, also thinner layers can be measured.

<sup>7)</sup> Sensor weight without optical fiber

# System design confocalDT

## Cable concepts for every application

The connection options are diverse and can be adapted to your plant or machine concept.

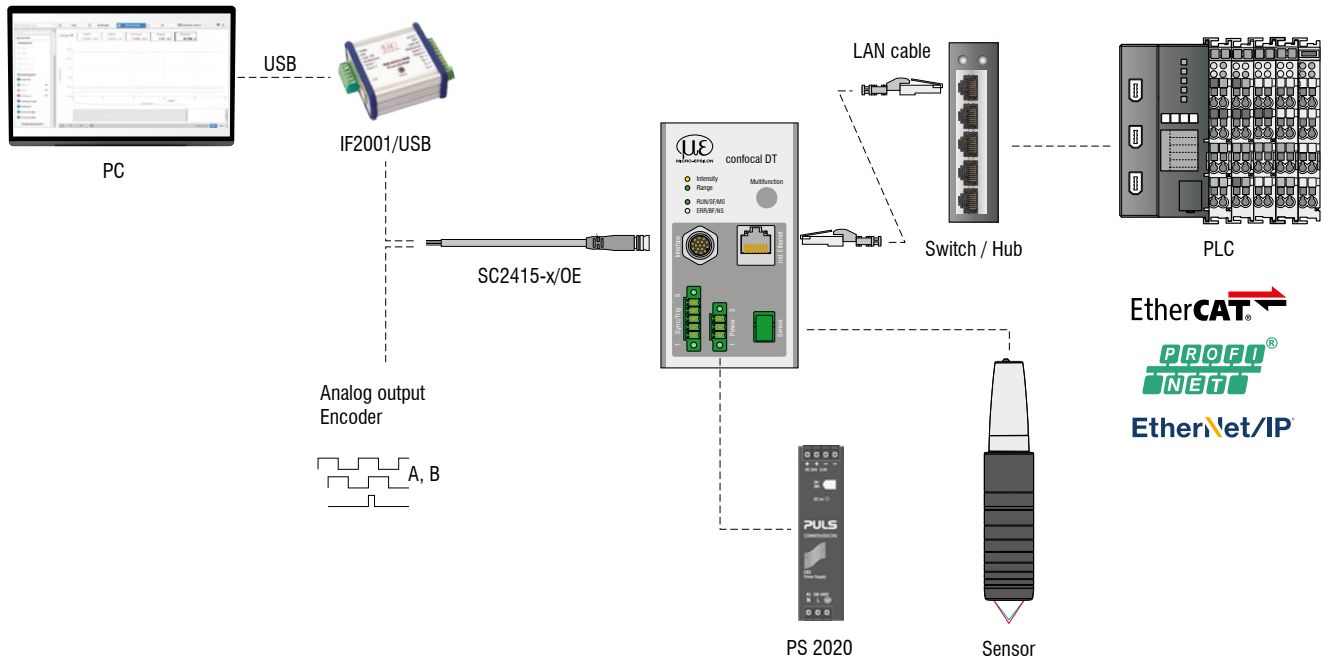
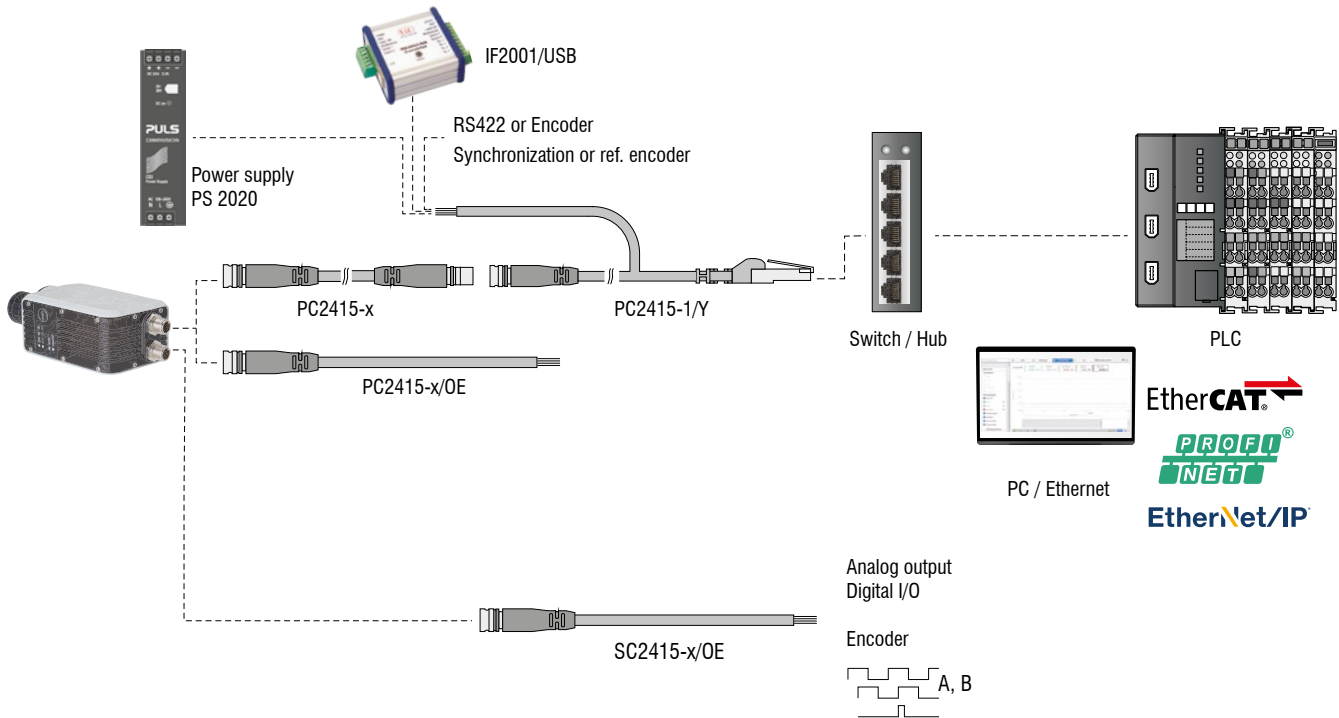

**The confocalDT system consists of:**

- Sensor IFS240x
- Controller IFC24xx
- Fiber optic cable C24xx

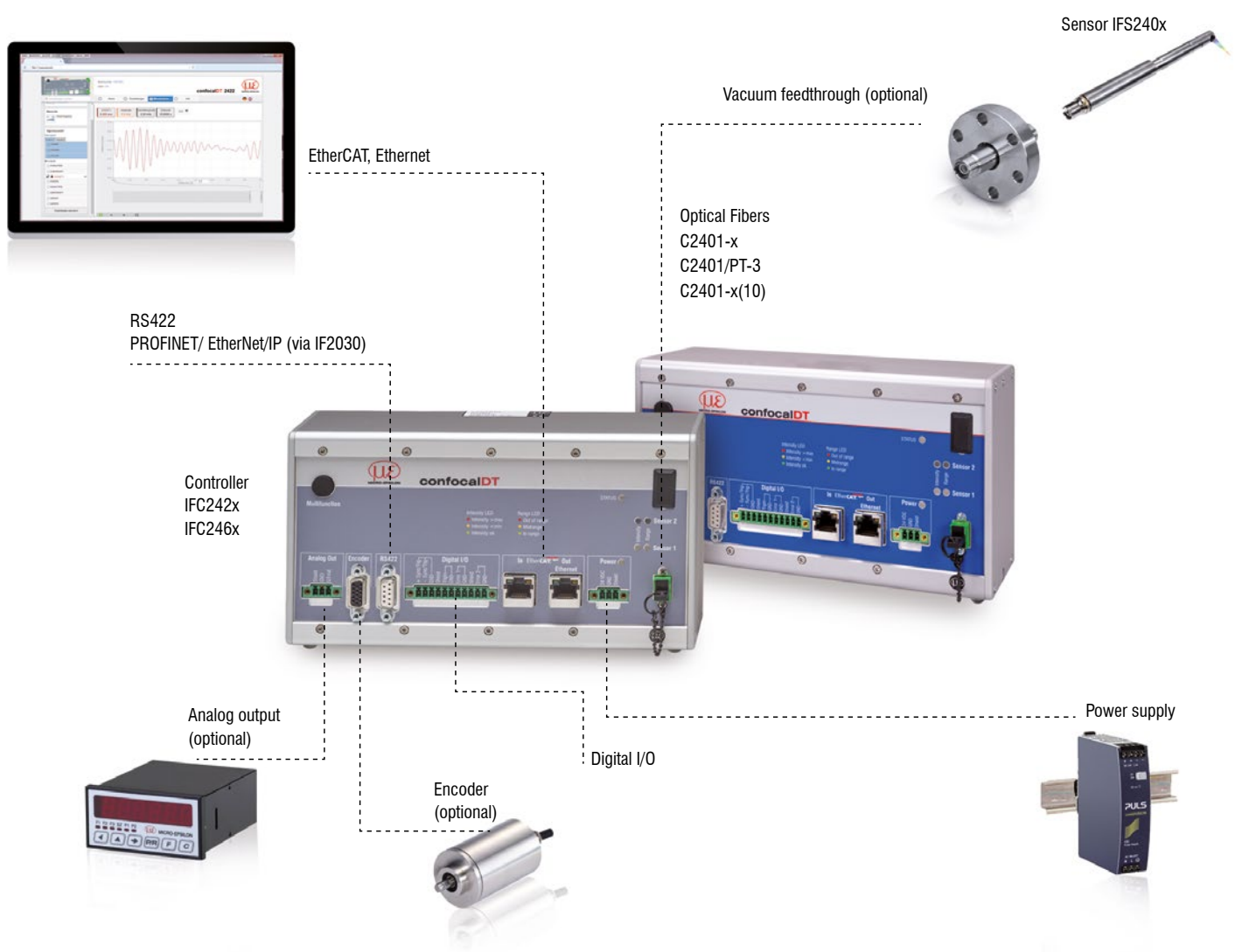

# Customer-specific modifications confocalDT

## Customer-specific modifications

Application examples are often found where the standard versions of the sensors and the controllers are performing at their limits. To facilitate such special tasks, it is possible to customize the sensor design and to adjust the controller accordingly. Common requests for modifications include changes in design, mounting options, customized cable lengths and modified measuring ranges.



### Possible modifications

- Sensors with connector
- Cable length
- Vacuum suitability up to UHV
- Specific lengths
- Customer-specific mounting options
- Optical filter for ambient light compensation
- Housing material
- Measuring range / Offset distance

## Vacuum setup

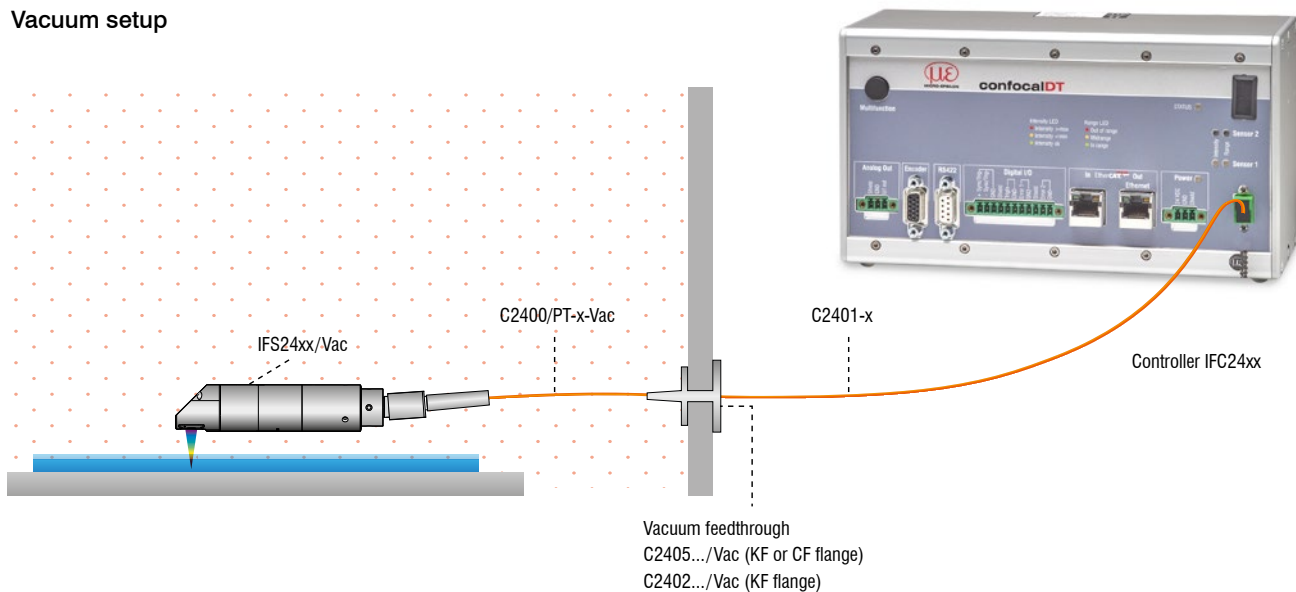

# Accessories

## Mounting adapter

Accessories: mounting adapter  
MA2402 for sensors 2402

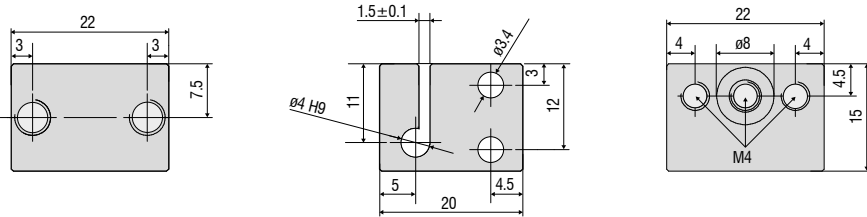

Accessories: mounting adapter  
MA2403 for sensors 2403

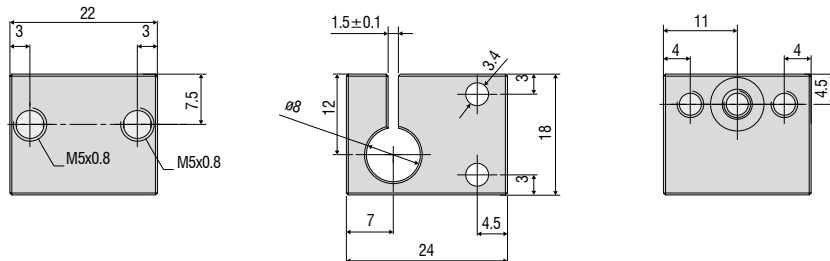

Accessories: mounting adapter  
MA2404-12 for sensors IFS2404-2 / IFS2404/90-2 / IFS2407-0,1

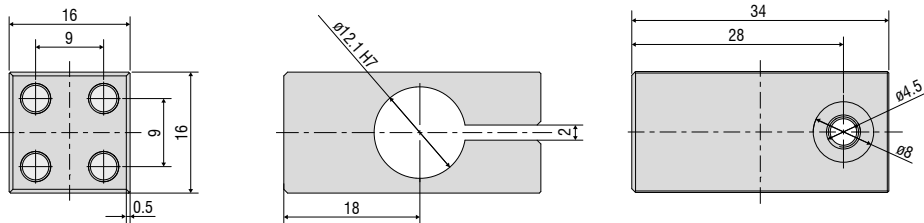

Accessories: mounting adapter  
MA2400 for sensors IFS2405 / IFS2406 / IFS2407 (consisting of a mounting block and a mounting ring)

Mounting block

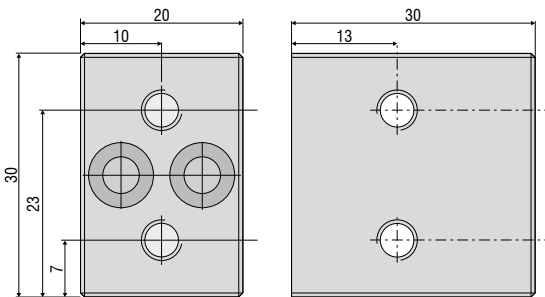

Mounting ring

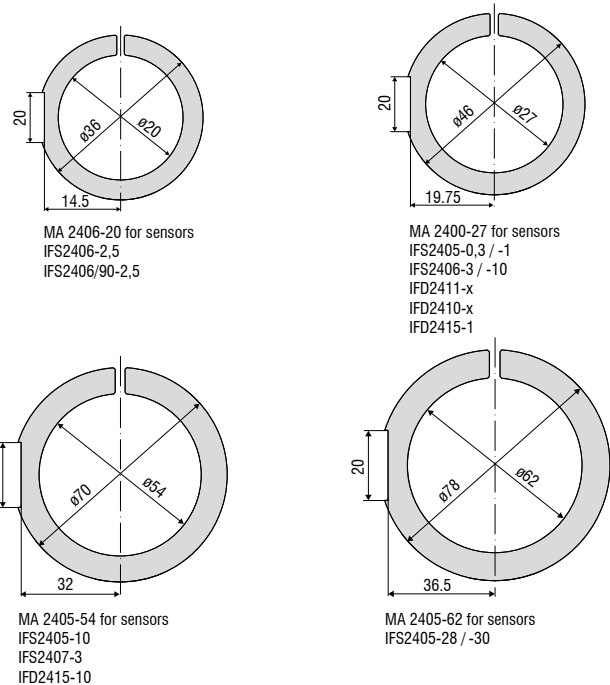

MA 2406-20 for sensors  
IFS2406-2.5  
IFS2406/90-2.5

MA 2400-27 for sensors  
IFS2405-0,3 / -1  
IFS2406-3 / -10  
IFD2411-x  
IFD2410-x  
IFD2415-1

MA 2405-34 for sensors  
IFS2405-3  
IFD2415-3

MA 2405-40 for sensors  
IFS 2405-6

MA 2405-54 for sensors  
IFS2405-10  
IFS2407-3  
IFD2415-10

MA 2405-62 for sensors  
IFS2405-28 / -30

## Adjustable mounting adapters

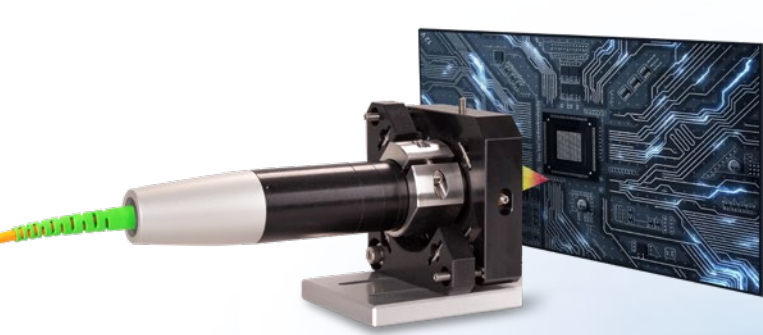

JMA-xx mounting adapter  
for distance measurements

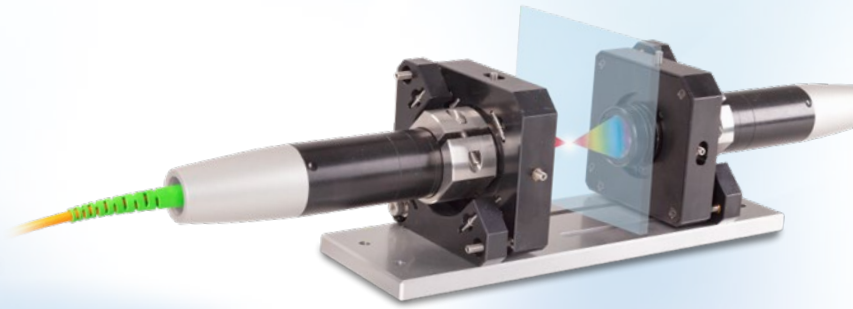

JMA-Thickness mounting adapter  
for two-sided thickness measurements

The adjustable JMA mounting adapter simplifies the alignment and fine adjustment of confocal sensors. The sensors are integrated and aligned directly in the machine together with the adapter. This corrects, e.g. minor deviations caused by mounting and compensates for tilted measuring objects. With two-sided thickness measurements, the JMA-Thickness mounting adapter supports the fine alignment of the two measuring points.

1 Max. shift in X  $\pm 2$  mm



2 Max. shift in Y  $\pm 2$  mm

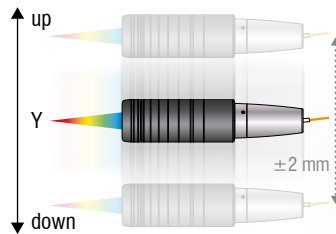

3 Max. tilt angle in X  $\pm 4^\circ$



4 Max. tilt angle in Y  $\pm 4^\circ$

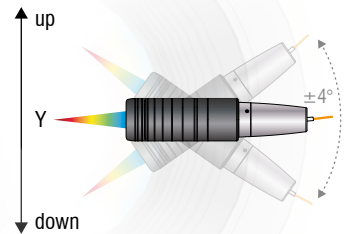



# Dimensions

## Adjustable mounting adapter JMA

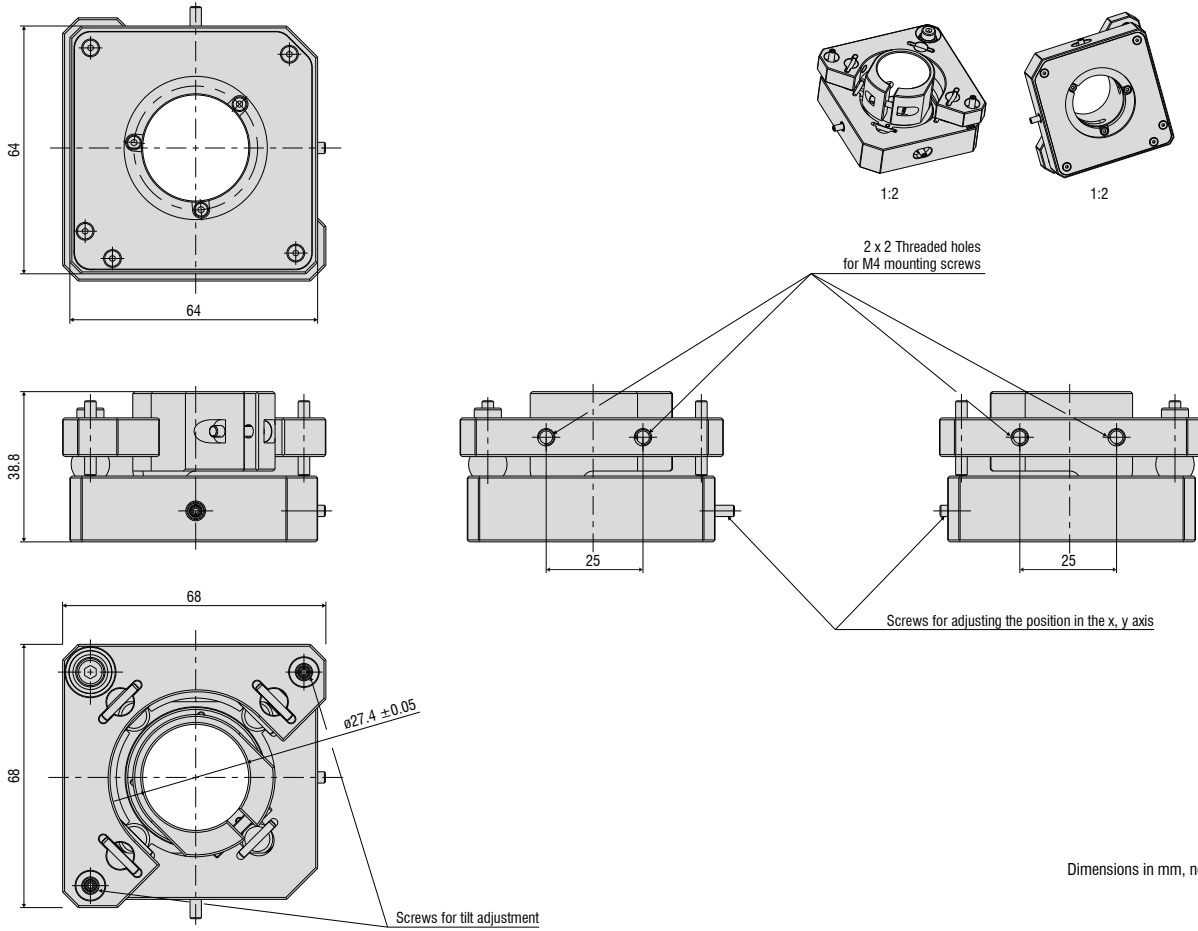

Dimensions in mm, not to scale

## Holder for smaller sensor diameters

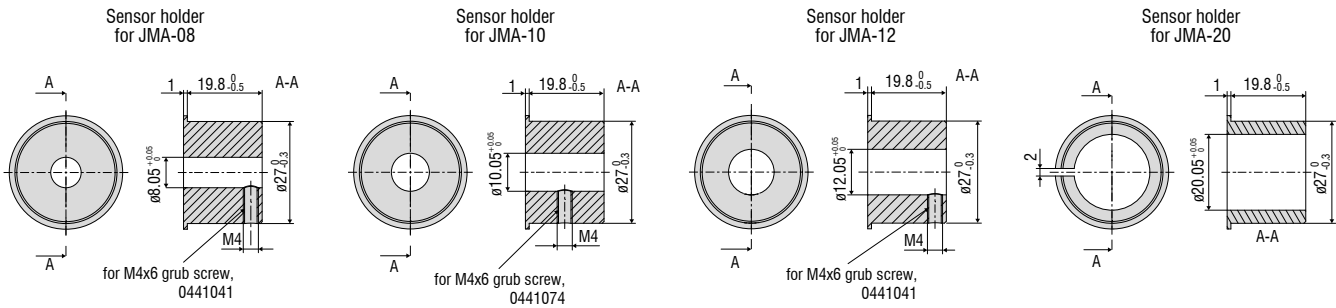

## Mounting plate JMP for JMA-Thickness

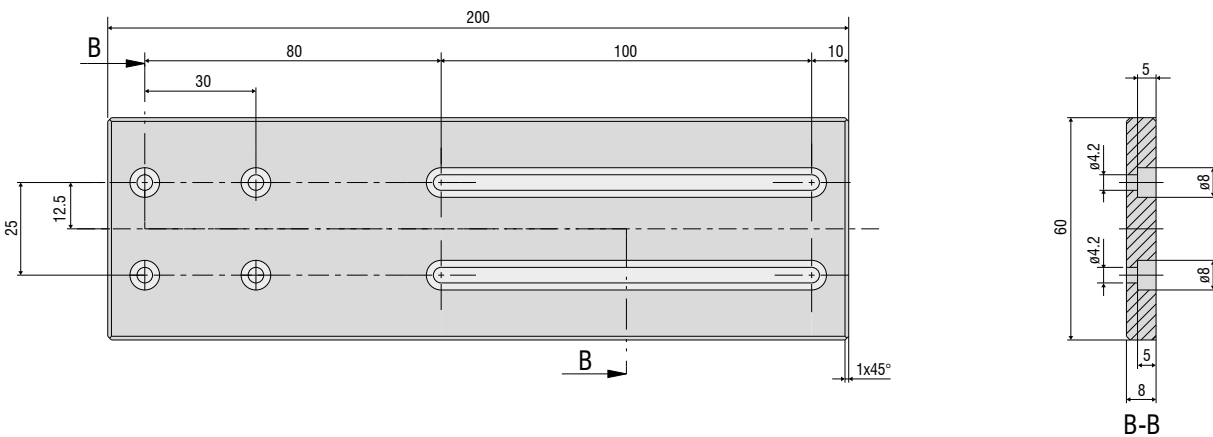

## Accessories

### Mounting adapter for individual sensors

Manual adjustment mechanism for easy and fast adjustment

Optimal sensor alignment for best possible measurement results

Ideally suitable for machine integration



Particularly for high resolution sensors with a small tilt angle, perpendicular installation is required. The JMA-xx mounting adapter enables fine alignment of the sensor to the target via the simple adjustment mechanism. This makes it easy to compensate for minor mounting deviations or tilted measuring objects.

#### Scope of supply

- 1 JMA-xx
- 1 sensor holder for smaller diameters (not with JMA-27)
- 1 hexagon screwdriver for positioning
- Assembly instructions

Model	JMA-08	JMA-12	JMA-20	JMA-27
Tilting range	X	±4° (continuously adjustable)		
	Y	±4° (continuously adjustable)		
Shifting range	X	±2 mm (continuously adjustable)		
	Y	±2 mm (continuously adjustable)		
Shock (DIN EN 60068-2-27)	15 g / 6 ms in XYZ axis, 1000 shocks each			
Vibration (DIN EN 60068-2-6)	2 g / 20 ... 500 Hz in XYZ axis, 10 cycles each			
Adjustment mechanism	Screw setting mechanism via M3x0.25 screw with hexagon socket 1.5			
Installation	2x 2 mounting holes for M4x1			
Sensor mounting	Radial clamping for ø 8 mm	Radial clamping for ø 12 mm	Radial clamping for ø 20 mm	Radial clamping for ø 27 mm
Compatibility	confocalDT: IFS2403 series	confocalDT: IFS2404-2 IFS2407-0,1 IFS2407-0,8	confocalDT: IFS2406-2,5/VAC interferoMETER: IMP-TH70	confocalDT: IFS2405-0,3 IFS2405-1 IFS2406-3 IFS2406-10 IFD2411-x

#### Application examples:

##### Alignment

Subsequent correction of the mounting position

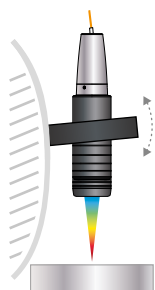

Compensates for incorrect target position

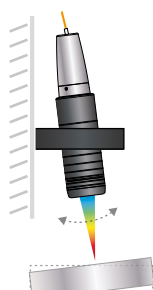

##### Positioning

Shifting the sensor to target area

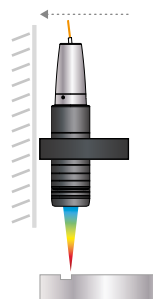

## Accessories

# Mounting adapter for two-sided thickness measurements

Optimal alignment of the optical axes enables high precision in two-sided thickness measurements

Pre-assembled for easy installation and fast commissioning

Ideally suitable for machine integration

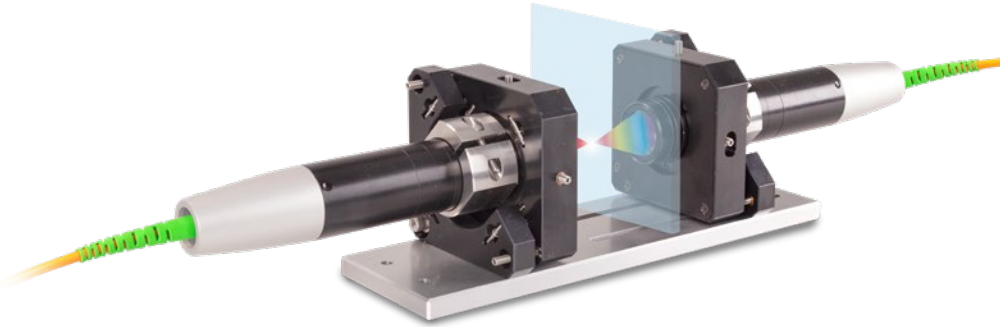

For two-sided thickness measurements, the JMA-Thickness mounting adapter supports the alignment of the measuring points to one another. This means that the measuring points are arranged absolutely congruent to each other so that the sensors are positioned exactly on an optical axis. This prevents measurements at an offset and a reliable measurement result is achieved with the highest possible precision.

When delivered, the two mounting adapters are pre-mounted on a mounting plate and aligned with one another. This simplifies installation and the measuring system can be put into operation more quickly. After installation into the machine, the plate can be removed, if necessary.

### Scope of supply

- 2 JMA-xx
- 1 JMP mounting plate
- 1 hexagon screwdriver 1.5 mm
- 1 Allen wrench 2.5 mm
- 1 Allen wrench 3.0 mm
- 1 Assembly instructions
- 2 optional reducing sleeves  
(depending on the package and the corresponding sensor)

Model	JMA-Thickness	-08	-12	-20	-27
Shock (DIN EN 60068-2-27)		15 g / 6 ms in XYZ axis, 1000 shocks each			
Vibration (DIN EN 60068-2-6)		2 g / 20 ... 500 Hz in XYZ axis, 10 cycles each			
Adjustment mechanism		Screw setting mechanism via M3x0.25 screw with hexagon socket 1.5			
Sensor mounting		Radial clamping for ø 8 mm	Radial clamping for ø 12 mm	Radial clamping for ø 20 mm	Radial clamping for ø 27 mm
Compatibility		confocalDT: IFS2403 series	confocalDT: IFS2404-2 IFS2407-0,1	confocalDT: IFS2406-2,5/VAC interferoMETER: IMP-TH70	confocalDT: IFS2405-0,3 IFS2405-1 IFS2406-3 IFS2406-10 IFD2411-x

## More precision with two-sided thickness measurements

<p><b>Without JMA-Thickness:</b> Measurement error with tilted target</p>	<p><b>Without JMA-Thickness:</b> Incorrect thickness measurement with vibrations</p>	<p><b>Without JMA-Thickness:</b> Sensors positioned incorrectly – no thickness measurement possible</p>
<p><b>With JMA-Thickness:</b> Measures exactly at the opposite position</p>	<p><b>With JMA-Thickness:</b> Sensors are on one optical axis – provides stability even with vibrating objects</p>	<p><b>With JMA-Thickness:</b> Optimal positioning support – object visible for both sensors</p>

# Accessories

## Cables and connectors

### Software

IFD24xx-Tool      Software demo tool included

### Light source accessories

IFL2422/LED      Lamp module for IFC2422 and IFC2466

IFL24x1/LED      Lamp module for IFC2421 and IFC2465

### Optical fiber extension for sensors

CE2402 cable with 2x E2000/APC connectors

CE2402-x          Extension for optical fiber (3 m, 10 m, 13 m, 30 m, 50 m)

CE2402/PT3-x      Optical fiber extension with protection tube for mechanical stress  
(3 m, 10 m, customer-specific length up to 50 m)

### Optical fibers for IFS2404/IFS2404-2 and IFS2404/90-2 sensors

C2404-x          Optical fiber with FC/APC and E2000/APC connectors  
Fiber core diameter 20  $\mu\text{m}$  (2 m)

### Optical fibers for IFS2405/IFS2406/2407-0,1/ IFS2407-3/IFD2411-x sensors

C2401 cable with FC/APC and E2000/APC connectors

C2401-x          Optical fiber (3 m, 5 m, 10 m, customer-specific length up to 50 m)

C2401/PT3-x      Optical fiber with protection tube for mechanical stress  
(3 m, 5 m, 10 m, customer-specific length up to 50 m)

C2401-x(01)      Optical fiber core diameter 26  $\mu\text{m}$  (3 m, 5 m, 15 m)

C2401-x(10)      Drag-chain suitable optical fiber (3 m, 5 m, 10 m)

C2400 cable with 2x FC/APC connectors

C2400-x          Optical fiber (3 m, 5 m, 10 m, customer-specific length up to 50 m)

C2400/PT-x      Optical fiber with protection tube for mechanical stress  
(3 m, 5 m, 10 m, customer-specific length up to 50 m)

C2400/PT-x-Vac    Optical fiber with protection tube suitable for use in vacuum  
(3 m, 5 m, 10 m, customer-specific length up to 50 m)

### Cables for IFD2410 /2415 sensors

PC2415-x          Supply/interface cable, drag-chain suitable,  
3 m, 6 m, 9 m, 15 m

PC2415-x/OE      Supply/interface cable open ends, drag-chain suitable,  
3 m, 6 m, 9 m, 15 m

PC2415-1/Y      Supply/interface cable Y, open ends and RJ45 plug,  
drag-chain suitable, 1 m

SC2415-x/OE      Multifunction cable, open ends, drag-chain suitable,  
3 m, 6 m, 9 m, 15 m

### Cables for IFD2411 sensors

SC2415-x/OE      Multifunction cable, open ends, drag-chain suitable, 3 m, 6 m, 9 m, 15 m

C2401-x          Optical fiber (3 m, 5 m, 10 m, customer-specific length up to 50 m)



Optical fiber C2401-x



Optical fiber with coating C2401/PT3-x



Drag-chain suitable optical fiber C2401-x(10)

### Optical fibers for IFS2407/90-0,3 sensors

C2407-x Optical fiber with DIN connector and E2000/APC (2 m, 5 m)

### Vacuum feedthrough

- C2402/Vac/KF16 Vacuum feedthrough with optical fiber, 1 channel, vacuum side FC/APC non-vacuum side E2000/APC, clamping flange KF 16
- C2405/Vac/1/KF16 Vacuum feedthrough on both sides FC/APC socket, 1 channel, clamping flange type KF 16
- C2405/Vac/1/CF16 Vacuum feedthrough on both sides FC/APC socket, 1 channel, flange type CF 16
- C2405/Vac/6/CF63 Vacuum feedthrough FC/APC socket, 6 channels, flange type CF 63

### Other accessories

- SC2471-x/USB/IND Connector cable IFC2461/71, 3 m, 10 m, 20 m
- SC2471-x/IF2008 Connector cable IFC2461/71-IF2008, 3 m, 10 m, 20 m
- PS2020 Power supply 24V / 2.5A
- EC2471-3/OE Encoder cable, 3m
- IF2030/PNET Interface module for PROFINET connection
- IF2030/ENETIP Interface module for EtherNet/IP connection

### Optical fiber

Temperature range : -50 °C to 90 °C

Bending radius: 30/40 mm

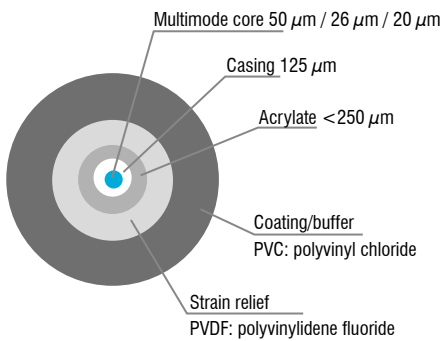

### E2000/APC standard connector

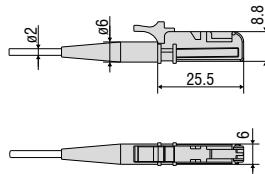

### FC/APC standard connector

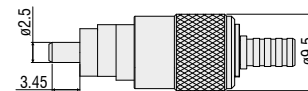

### DIN connector

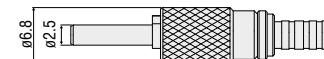

# Accessories

## Interface modules

Module	IFC2410	IFC2411	IFC2415	IFC242x	IFC246x
<b>IF2001/USB</b> Single-channel RS422/USB converter cable	✓	✓	✓	✓	✓
<b>IF2004/USB</b> RS422/USB converter to convert up to 4 digital signals to USB	⊘	⊘	⊘	✓	✓
<b>IF2008/ETH</b> Interface module for Ethernet connection for up to 8 sensors	⊘	⊘	⊘	✓	✓
<b>IF2008PCIE</b> Interface card for multiple sensor signals; analog and digital interfaces	⊘	⊘	⊘	✓	✓
<b>IF2035/PNET</b> Interface module for Industrial Ethernet connection (PROFINET)	⊘	⊘	⊘	✓	✓
<b>IF2035/ENETIP</b> Interface module for Industrial Ethernet connection (EtherNet/IP)	⊘	⊘	⊘	✓	✓

### IF2001/USB converter RS422 to USB

The RS422/USB converter converts the digital signals of a confocal controller into a USB data packet. The sensor and the converter are connected via the RS422 interface of the converter. Data output is done via USB interface. The converter loops through further signals and functions such as laser on/off, switch signals and function output. The connected controllers and the converter can be programmed through software.

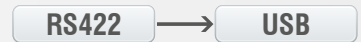
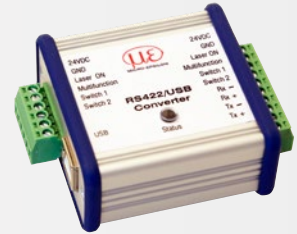

#### Special features

- Robust aluminum housing
- Easy sensor connection via screw terminals (plug and play)
- Conversion from RS422 to USB
- Supports baud rates from 9.6 kBaud to 12 MBaud

### IF2004/USB: 4-channel converter from RS422 to USB

The RS422/USB converter is used for transforming digital signals of up to four confocal controllers into USB data signals. The converter has four trigger inputs and a trigger output for connecting additional converters. Data is output via an USB interface. The connected controllers and the converter can be programmed through software. The COM interfaces can be used individually and can be switched.

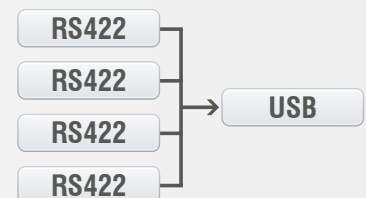

#### Special features

- 4x digital signals via RS422
- 4x trigger inputs, 1x trigger output
- Synchronous data acquisition
- Data output via USB

## IF2008/ETH

### IF2008/ETH Interface module for Ethernet connection with up to 8 sensors

The IF2008/ETH integrates up to eight sensors and/or encoders with an RS422 interface into an Ethernet network. Four programmable switching in-/outputs (TTL and HTL logic) are available.

10 indicator LEDs directly on the module show both the channel and the device status. In addition, acquisition and output of data via Ethernet is in addition performed at high speeds up to 200 kHz. Parameter setting of the interface module can be easily done via the web interface.



## IF2008PCle/IF2008E

### Interface card for synchronous data acquisition

Absolute synchronous data acquisition is a decisive factor for the deflection or straightness measurement using several controllers. The IF2008PCle interface card is designed for installation in PCs and enables the synchronous acquisition of four digital sensor signals and two encoders. The data is stored in a FIFO memory in order to enable resource-saving processing in blocks in the PC. The IF2008E expansion board enables to detect in addition two digital controller signals, two analog controller signals and eight I/O signals.

#### Special features

- IF2008PCle - Basic printed circuit board: 4 digital signals and 2 encoders
- IF2008E - Expansion board: 2x digital signals, 2x analog signals and 8x I/O signals

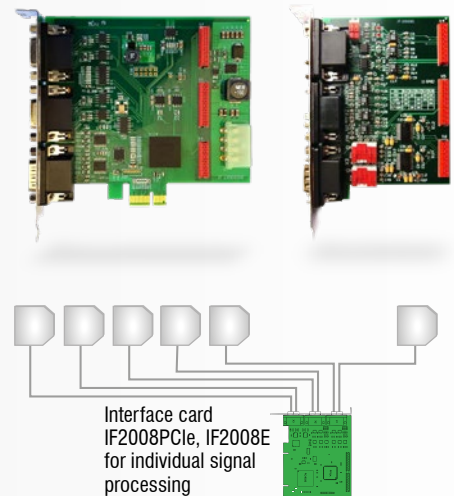

## IF2035

### Interface module for Industrial Ethernet connection

The IF2035 interface modules are designed for easy connection of Micro-Epsilon sensors to Ethernet-based fieldbuses. The IF2035 is compatible with sensors that output data via an RS422 or RS485 interface and supports the common Industrial Ethernet protocols EtherCAT, PROFINET and EtherNet/IP.

These modules operate on the sensor side with up to 4 MBd and have two network connections for different network topologies. In addition, the IF2035-EtherCAT offers a 4-fold oversampling function, which enables faster measurements than the bus cycle allows, if required. Installation in control cabinets is via a DIN rail.



## Sensors and Systems from Micro-Epsilon



Sensors and systems for displacement, distance and position



Sensors and measurement devices for non-contact temperature measurement



Measuring and inspection systems for metal strips, plastics and rubber

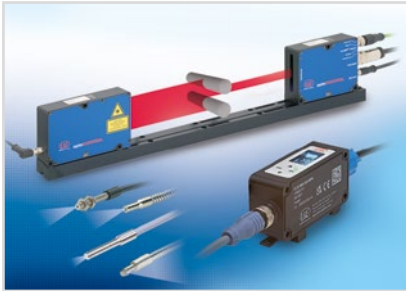

Optical micrometers and fiber optics, measuring and test amplifiers



Color recognition sensors, LED analyzers and inline color spectrometers



3D measurement technology for dimensional testing and surface inspection